



DICE interface for iPod

for selected Toyota/Lexus/Scion vehicles

Installation Guide/User Manual



SILVERLINE

Copyrights and Trademarks

Copyright 2008 DICE Electronics, LLC.

The DICE Electronics logo is a trademark of DICE Electronics, LLC.

iPod is a trademark of Apple, Inc.

All rights reserved.







Printed in the U.S.A

Table of contents

| | |
|---|-----------|
| Copyrights and trademarks | 2 |
| Icon legends | 3 |
| Warranty and safety | 4 |
| Product registration | 5 |
| Supported iPod models | 6 |
| iPod hierarchy | 7 |
| Charging | 7 |
| Integration kit contents | 8 |
| Identify your car | 9 |
| DIP switches | 10 |
| DIP switch settings | 11 |
| Installation | 13 |
| iPod audio source | 17 |
| Controls in CDC/MD emulation | 17 |
| Controls in MP3 emulation | 19 |
| Text display fields in CDC/MD/MP3 emulation | 20 |
| Browsing function in CDC/MD/MP3 emulation | 21 |
| Controls in SAT emulation | 22 |
| Text display fields in SAT emulation | 24 |
| Browsing function in SAT emulation | 25 |
| Scrolling feature | 26 |

| | |
|-------------------------------|-----------|
| Auxiliary audio source | 27 |
| Troubleshooting | 29 |
| Disclaimer | 31 |

Icon legends

| | |
|--|--------------------------|
|  | Turn jog dial |
|  | Turn jog dial repeatedly |
|  | Press button |
|  | Press button repeatedly |
|  | Press and hold button |
|  | Scroll |

Warning and safety!

Please read these instructions carefully before proceeding. Failure to follow instructions may result in improper operation or injury. Neither DICE Electronics, LLC. nor Apple Inc., its regional offices, distributors or resellers take any responsibility for any damage or injury as a result of using the integration kit.

- Do not open, disassemble or alter the interface in any way.
- Do not insert anything into the casing.
- Do not cut or try to alter cables in any way and always use the correct connections.
- Only operate unit when stationary or ask passengers to operate it for you.
- Do not allow the Apple iPod to distract you from driving.
- Exercise good judgement and keep your eyes on the road at all times.
- Do not expose unit to extreme temperatures, humidity or shock.
- Keep the unit and iPod away from fluids.
- Keep away from children! - Interface components may contain small parts, can be broken or disassembled and components may become loose from vibration and heat. Small components and packaging materials may be a choking hazard when handled by children.



Congratulations on your purchase

Thank you for purchasing the DICE integration kit for iPod. Please review our user manual and installation guide before operating the unit. This interface was designed and manufactured to seamlessly integrate with your vehicle's factory entertainment system.

Product registration

In order to validate your warranty period and to receive telephone or online support, you **MUST** register your DICE product.

To register your DICE product, please complete the following steps:

1. Visit <http://www.diceelectronics.com/register>
2. Complete the product registration form.
3. Submit the form.
4. Save the registration/support/warranty sheet in a safe place for future reference.

If you are unable to complete the registration via internet, please call DICE Electronics at 1-888-342-3999.

Supported iPod models and firmware version requirements

FW:3.1.1



iPod
4th generation
20GB 40GB

FW:1.2.1



iPod
4th generation color display
20GB 30GB 40GB 60GB

FW:1.0.3



iPod classic
80GB 160GB

FW:1.2.1



iPod
5th generation (video)
30GB 60GB 80GB

FW:1.4.1



iPod mini
4GB 6GB

FW:1.0.3



iPod nano
3th generation (video)
4GB 8GB

FW:1.3.1



iPod nano
1st generation
1GB 2GB 4GB

FW:1.1.3



iPod nano
2nd generation (aluminum)
2GB 4GB 8GB

FW:1.1.1



iPod touch
8GB 16GB 32GB

For the latest firmware versions and models not listed, please contact your authorized dealer or DICE Electronics, LLC.

iPod hierarchy

By default, the interface creates a Playlist having a name that is the same as the name of the iPod. This Playlist is the very first on the list of Playlists shown while browsing in Playlist mode. This Playlist contains all the songs on the iPod. Once a Playlist is active an Artist may be selected within that Playlist using the Artist Mode. Albums by the selected Artist and within the selected Playlist may be selected in Album Mode. "ALL ARTIST" and "ALL ALBUM" designate all available content in those categories.



Charging

The interface automatically charges the battery of the iPod when connected and the key is in the ACC/ON position.

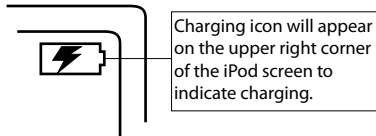

Integration kit contents

- 1 Vehicle specific interface unit
- 1 Vehicle specific harness (R2)
- 1 iPod docking cable
- 1 User manual

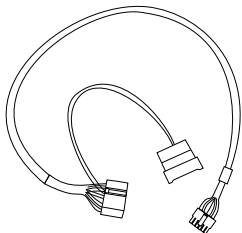
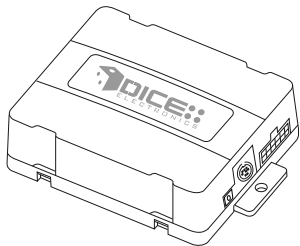
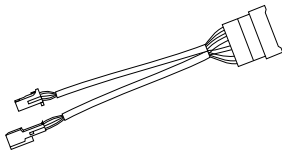
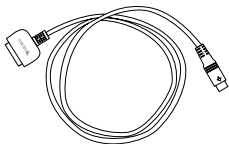

Identify your audio system

Select the emulation that best suits your vehicle. The following chart identifies the recommended emulation for the listed radios. Note that your vehicle may support more than one type of emulation.

| Radios | External CDC | Factory SAT | CDC | MD* | SAT** | MP3 |
|-----------------------|-------------------------------|---------------|-----|-----|-------|-----|
| 98-02 Tape/in-dash CD | not installed or disconnected | not available | ✓ | ✓ | X | X |
| 98-02 Tape/in-dash CD | present | not available | X | ✓ | X | X |
| 03-06 Tape/CD | not installed or disconnected | not installed | ✓ | ✓ | ✓ | X |
| 03-06 Tape/CD | not installed or disconnected | present | ✓ | ✓ | X | X |
| 03-06 Tape/CD | present | not installed | X | ✓ | ✓ | X |
| 03-06 Tape/CD | present | present | X | ✓ | X | X |
| 06-07 MP3 Navigation | not available | not present | X | X | ✓ | ✓ |
| 06-07 MP3 Navigation | not available | present | X | X | X | ✓ |

* Not all radios support MD mode. If an external MD changer is present, it must be disconnected.

** Scrolling function is available in Satellite mode, please see p. 26 for details.

Dip switches

The configuration switches located on the DICE module are used to set the operation of the interface by the installer. Incorrect dip switch settings may cause the DICE interface not to work properly or not to operate at all. **Disconnect the vehicle harness from module and cycle ignition off for 50 seconds after changing the switches!**

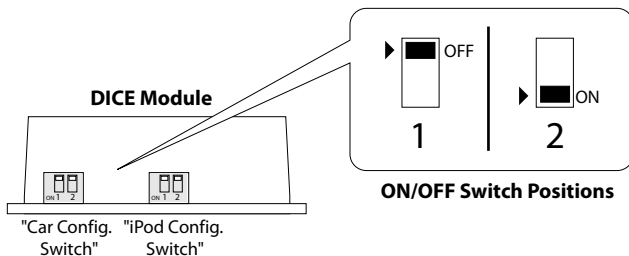

Dip switch settings

| Car configuration switches | | | | | | | |
|--|--------------|--|--------------|---|--------------|--|--------------|
| Settings | | | | | | | |
| CD changer (CDC) | | Mini DISC (MD) | | Satellite (SAT) | | MP3 | |
| Dip switch 1 | Dip switch 2 | Dip switch 1 | Dip switch 2 | Dip switch 1 | Dip switch 2 | Dip switch 1 | Dip switch 2 |
| OFF | OFF | ON | OFF | ON | ON | OFF | ON |
| <p>Recommended for radios NOT supporting Satellite (XM) or if factory SAT is installed and user wishes to retain it. Selected vehicles from 2003 offer CD Text - these radios have a Text button.</p> | | <p>Recommended for early model year radios with external CD changer. MD Text is only available on very few radios, typically navigation ones.</p> | | <p>Recommended for radios if SAT module is not present or disconnected and an external CD changer is used. SAT mode is supported by high-end radios in selected models from 2003 in the US only.</p> | | <p>Recommended for late model Navigation radios only where factory SAT is installed and user wishes to retain it. Radios must support MP3 text. New MP3 navigation cars support only MP3 text not CD Text.</p> | |

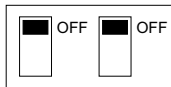

Default

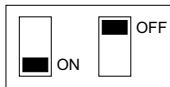

| iPod configuration switches | | | |
|---|--------------|--|--------------|
| Settings | | | |
| "Locked" | | "iPod" | |
| Dip switch 1 | Dip switch 2 | Dip switch 1 | Dip switch 2 |
| OFF | OFF | ON | ON |
| <p>It is best selected when Text display is supported by the radio. After connecting the iPod you will see the DICE logo on the screen. After the initialization the iPod will be locked for an increased interface functionality.</p> | | <p>It is best selected when Text display is NOT supported by the radio. Track numbers and times are not synchronized between the iPod and radio. Because there is less data transfer between the iPod and radio, this mode has the fastest response time. Content is selected on the iPod.</p> | |

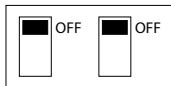

Default



Installation

Installation should only be performed by a qualified professional. Beware of sharp edges to avoid injury and exercise caution when removing trims as they may break. The module should be placed at an accessible location to allow AUX cable to be connected, such as in the glove box, the center console or under the front seat.

- 1 Pull vehicle into service bay and access radio/center console.
- 2 Disconnect both battery terminals. These cables must be disconnected during installation to ensure proper initialization of the module when it is connected.
- 3 Before pulling out the radio, removing surrounding trims and screws. Most trims can be removed by carefully pulling on the piece or using trim removal tools. Trim is usually held in place by snap-in clips.
- 4 The radio is held in place by a few bolts. To remove these a 10mm socket is usually needed. Consult your dealership if additional information is needed on removing the radio.

5a - Radios with large connector - You can access the CD changer connector located on the back of the radio. Unplug the factory connection if present and plug the Toyota BUS connector into the receptacle. Plug the factory connection to the cable receptacle if it was removed from the radio. The connector should securely lock.

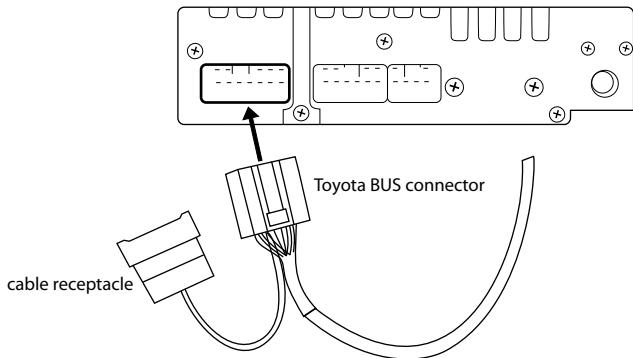

The cable receptacle is only for cars where the steering wheel control was plugged into the radio. To operate the interface in CDC/MD mode together with the factory CD Changer/MD Changer you need to obtain a Y cable (not included) from a Toyota dealership.

5b - Radios with small connector -You can access the CD changer connector located on the back of the radio. Unplug the factory connection if present and plug the Toyota BUS connector in. Connect the factory plug to the cable receptacle if it was removed from the radio. The extension receptacle mates with the vehicle specific harness. The connector should securely lock.

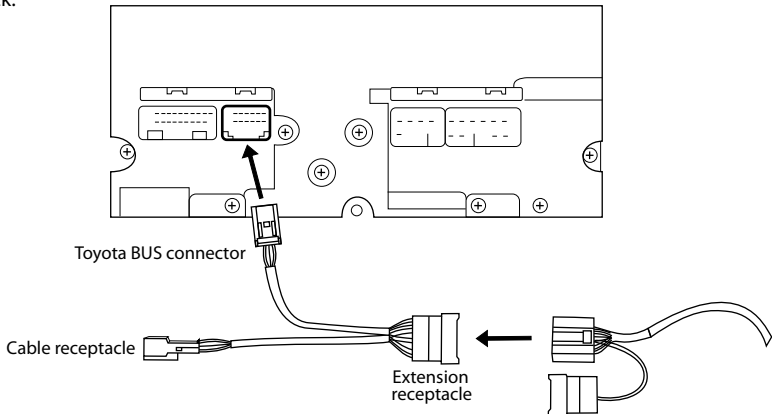

- 6** Connect the vehicle specific connector and the iPod docking cable to the DICE module. Apply cable ties to secure the cables.

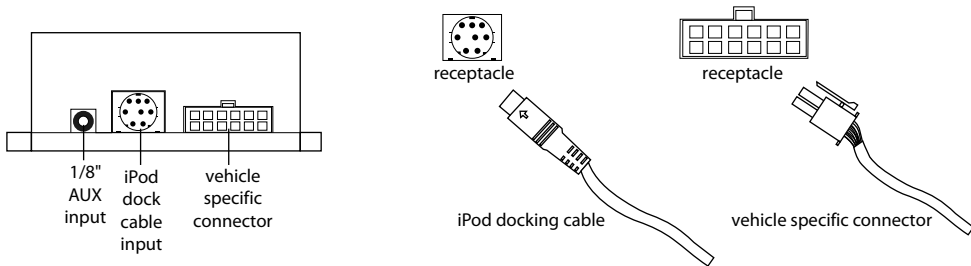

- 7** Verify that all connections have been properly made.

- 8** Reconnect the car's battery. Test the unit before seating the cables and reinstalling the panels/trim.

iPod audio source

Controls in CDC/MD emulation

Press the CD/CDC/DISC button to access the interface and its features. Pressing this button repeatedly will cycle through sources present (internal CD if present, followed by external) in your vehicle. When the iPod audio source is active (DISC 5, Track1), use the Seek track button to select next/previous Song. Note that radios without a Text button will only display DISC and Track numbers.

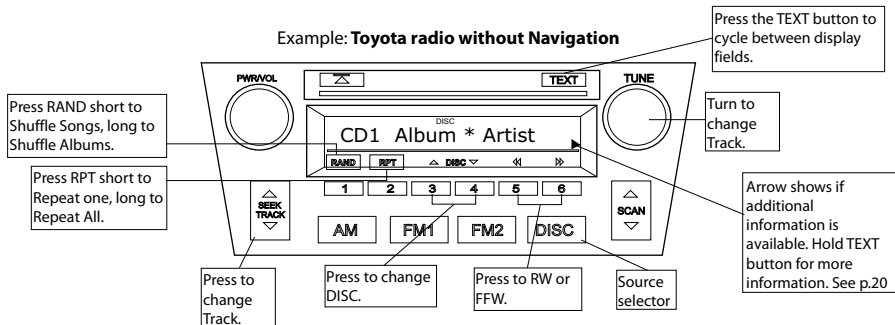

Example: **Toyota radio with Navigation**

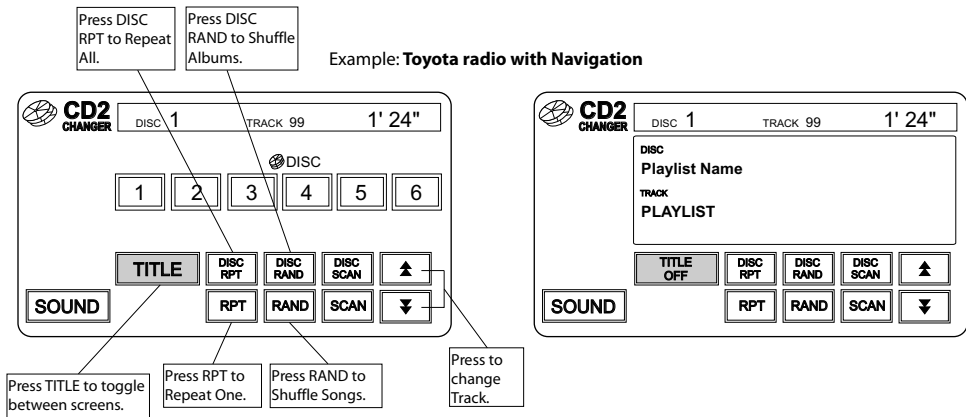

Note that in MD mode MD1/2 will be displayed instead of CD1/2.

Controls in MP3 emulation

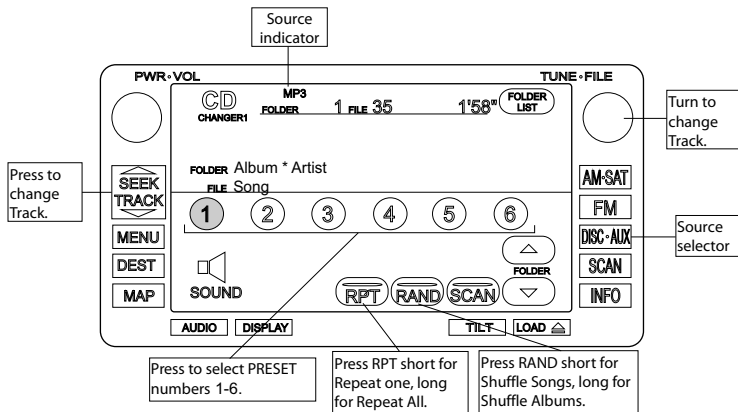

Text display fields - CDC/MD emulations, Non-Navigation radios

Press the Text button to cycle through the available Text fields. In CDC and MD mode there are two available text fields. Please see illustration below in Playlist mode (DISC 2):



Text is paged in these modes (where supported). Additional text information can be viewed by pressing and holding the Text button. A little arrow in the right bottom corner indicates additional page of text information:



Silverline browsing function - in CDC/MD/MP3 emulation

The Silverline integration kit features content browsing. After connecting the iPod, select the desired browsing mode by selecting the appropriate DISC. Press the Seek button or turn the Tune dial repeatedly to browse contents; 1 second after releasing the button, your selection is executed. The browsing function below is illustrated in the "Track" text field.

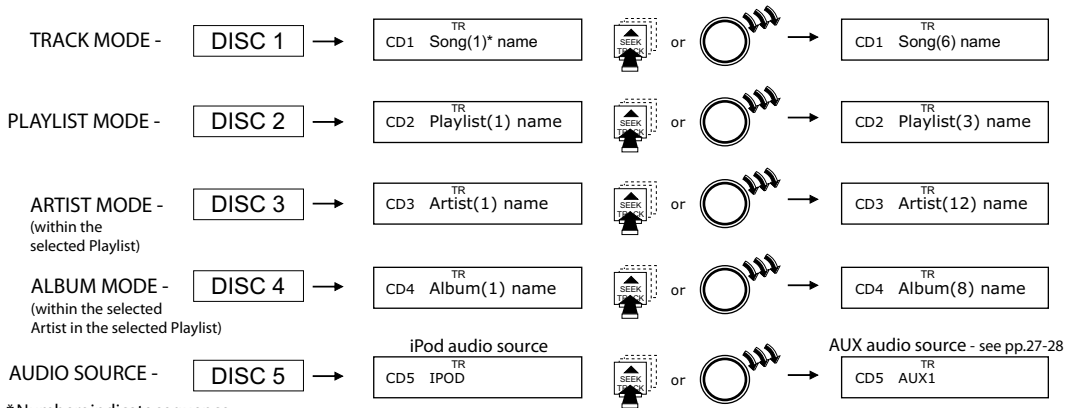

* Numbers indicate sequence.

Controls in SAT emulation

Press the AM/SAT button to access the interface and its features. When the iPod audio source is active (Preset 5, Channel 1), use the Seek button or the Tune dial to select next/previous Song.

Example: **Toyota radio without Navigation**

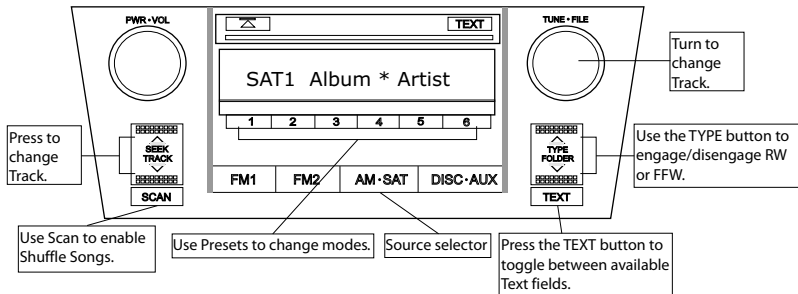

Example: **Toyota radio with Navigation**

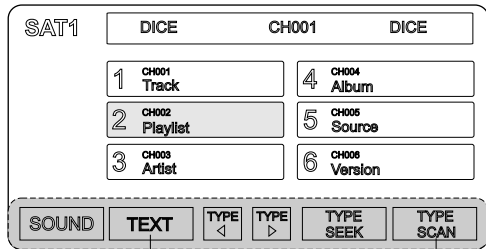

Press the TEXT button to toggle between available screens.

Use TYPE SCAN to enable Shuffle Songs.

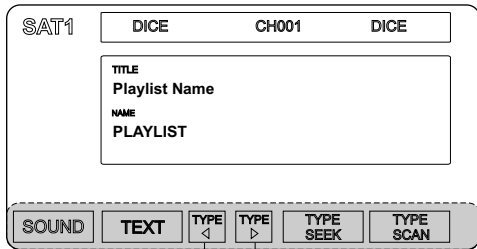

Use the TYPE button to engage/disengage RW or FFW.

Illustration for touch screen systems

Text display fields - SAT emulations, Non-Navigation radios

Press the Text button to cycle through Text fields. In SAT emulation there are three available text fields. Please see illustration below for Track mode (Preset 1):

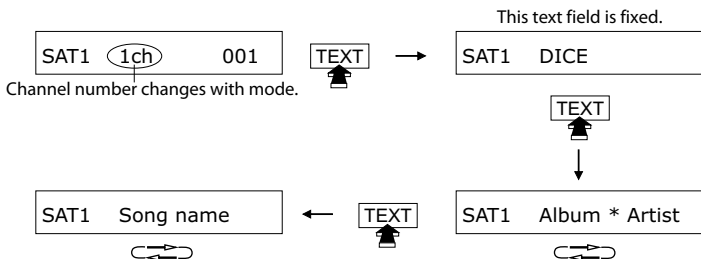

Silverline browsing function - in SAT emulation

The Silverline integration kit features content browsing. After connecting the iPod, select the desired browsing mode by pressing the appropriate Preset button. Press the Seek button or turn the Tune dial repeatedly to browse contents; 1 second after releasing the button, your selection is executed.

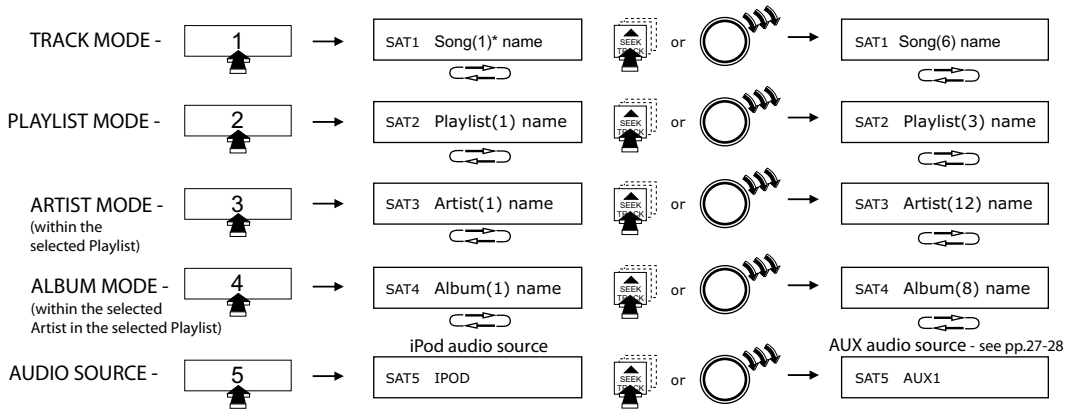

AUX audio source - see pp.27-28

* Numbers indicate sequence.

Scrolling feature - in SAT emulation, PRESET 6

To set and change scrolling feature go to Preset 6 and press the Text button. Change options by pressing Seek track or turning the Tune dial. **After setting the desired feature turn off the ignition for at least 50 seconds to engage the new selection.**



Certain amount of blinking is normal on some radios when the scrolling feature is on.

Auxiliary audio source

Connections

The interface is equipped with a 1/8" AUX jack connection to connect an auxiliary device, such as an MP3 player, DVD player or other audio source. To access the AUX audio source, select DISC 5, Track 2 or Preset 5, Channel 2.

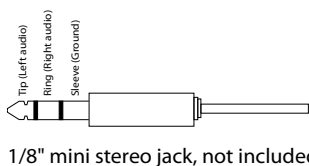
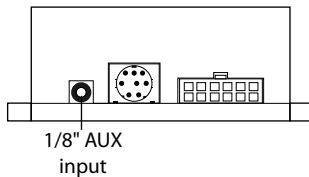

Making the adjustments

While listening to the auxiliary device, adjust the volume (gain), bass, mid and treble by turning the Tune dial or pressing the Seek button. DISC/Preset 1-4 modes select what adjustment the Tune/Seek buttons perform. See illustration on page 28.

AUX audio source setting

The auxiliary input has settings for **gain**, **bass**, **mid** and **treble** in order to optimize sound.

Volume (Gain) should be adjusted if the audio level from the auxiliary device is too low or too high. If you hear distorted audio while playing the auxiliary device, you need to reduce (-) the gain. If you notice that the audio is too quiet then the gain setting should be increased (+). Default settings are "50" ("68" for gain) and values may be adjusted in increments between 01-99. **Bass**, **Mid** and **Treble** should be adjusted to compensate for the acoustic presets of the radio.

Note: If you are using an AUX device that is using the vehicle's power source and not its own battery, you may have to use a GROUND-LOOP isolator to avoid grounding and engine noise.

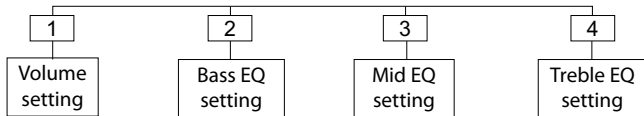

Troubleshooting

| Problem | Solution |
|---|--|
| Cannot select the interface. | Check DIP switch settings (refer to p.11). With the ignition OFF disconnect vehicle harness from module for a few seconds and reconnect. Verify that the correct button is used to access the interface. |
| No audio from iPod source. | Reset the iPod. Verify proper connection to iPod/interface. |
| Radio/ steering wheel controls do not operate iPod. | Reset iPod and make sure most recent iPod firmware is installed. Check vehicle user manual on how steering wheel controls work. |
| No text display. | Make sure DIP switch settings are correctly set for text display. (Refer to pp.11, 12 for dip switch settings.) |

Troubleshooting

| Problem | Solution |
|---|---|
| Text is not displaying in selected emulation. | Identify your audio system first (p.9) and set switches accordingly. Note that your vehicle may support more than one mode. |
| iPod does not charge. | Check all connections. Reset iPod and make sure iPod charges while connected to computer or wall charger. |
| Music is distorted or sound level is too low. | Check and make sure all EQ and BASS boost options are turned off on your iPod. (Refer to AUX settings on p.28) |
| Radio/Nav display only shows DISC/Preset and Track/Channel numbers, but there is no iPod control. | Select DISC/Preset 5 and make sure it is set to Track/Channel 1. |

Disclaimer and warranty

Important disclaimer, please read!

Unauthorized reproduction or reverse engineering is strictly prohibited! Intellectual property included is distributed under specific license agreement with respective owners and is licensed only, not sold. No warranty, explicit or implied, is stated. Neither DICE Electronics, LLC., nor any of its agents, distributors, dealers or vendors shall be liable for damages.

IN NO EVENT SHALL DICE ELECTRONICS' LIABILITY EXCEED THE PRICE PAID FOR THE PRODUCT FROM DIRECT, INDIRECT, SPECIAL, INCIDENTAL, OR CONSEQUENTIAL DAMAGES RESULTING FROM THE USE OF THE PRODUCT, ITS ACCOMPANYING SOFTWARE OR ITS DOCUMENTATION.

Warranty and Support

Products carry a 90 day limited warranty that protects you from defects in material and workmanship of products sold by DICE Electronics, or its authorized agents, distributors and dealers. The warranty period begins the day a product is purchased by the end user. Products found to be defective during the warranty period will either be repaired or replaced by DICE Electronics at no charge unless warranty is void. Unauthorized attempt of repair or alteration of the product in any way immediately voids this warranty. Warranty does not extend to cosmetics or finish. A DICE product specialist must determine that defect is present in the product and issue an RMA. Be sure that all wiring is connected as described in the user manual and all related equipment is functioning properly. DICE Electronics disclaims any liability for other incurred damages resulting from product defects. Any expenses in the removal and reinstallation of products are not covered by this warranty.

If experience any problems or need help, please contact your local dealer or call 888-342-3999, or visit our support site at <http://www.diceelectronics.com/support>.



Toyota/Lexus/Scion compatible integration for iPod
www.diceelectronics.com

Toyota/Lexus/Scion-iPod 2008-02

SILVERLINE